

886 Facility Post

with Standard Width Webbing

Perfect for indoor and outdoor use. Features a heavy duty base with easy carry handles. Ideal for health and safety applications.

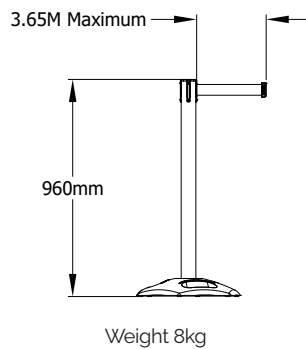
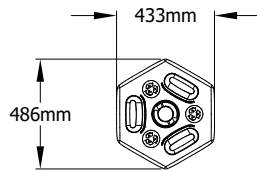
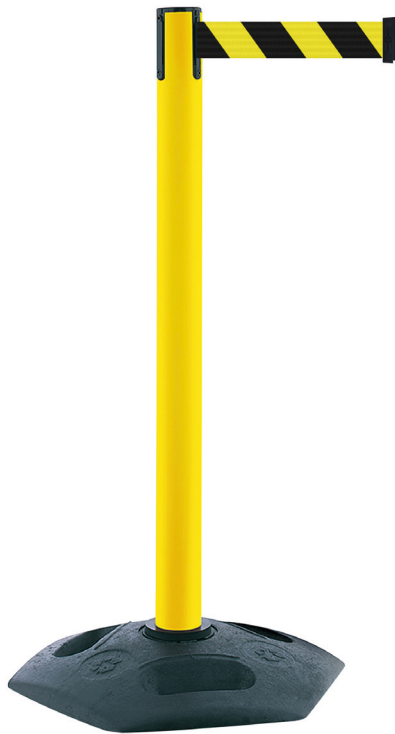
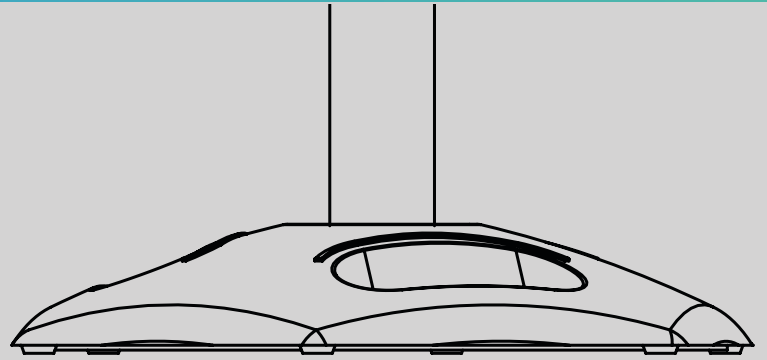

Features & Benefits

- The facility post features a lightweight plastic post that screw fixes into a recycled rubber heavy duty base.
- The post and base can be quickly and easily dismantled for easy storage and transportation.
- The robust base can be walked or driven over and it will still retain its shape and function.
- Ideal for indoor and outdoor use, but shouldn't be permanently placed outside.
- The safest barrier on the market – our cassettes have a unique braking system for slower webbing retraction.

Product Specification

- Plastic post available in 4 UV stable colours.
- Black recycled rubber base with easy carry handles, which allows for the post to be easily screwed into place.
- Shipped flat packed with no tools required.
- Available with any Tensator® standard (50mm) webbing options.
- Modular webbing cassette – all cassettes come as standard with our four-point anti-tamper webbing connectivity. This allows you to connect other Tensabarrier® products to the receiver splines on the cassette head.
- Compatible with all Tensabarrier® accessories including our range of post top signage.
- Available to buy in a twin pack.

Applications

- Eliminate unsafe working conditions by clearly defining routes.
- Restrict access to dangerous areas.
- Use to identify hazards before they cause harm.
- Ideal for warehouses, industrial and maintenance areas.
- Indoor and outdoor use.

Order Code

- 886-STD – Single Pack - Facility Post 2.3m
- 886-MAX – Single Pack - Facility Post 3.65m
- 886/2-STD – Twin Pack - Facility Post 2.3m
- 886/2-MAX – Twin Pack - Facility Post 3.65m

Product Configuration

Base Options



Heavy Duty Base

Post Finishes



Four plastic finishes available

Webbing Options

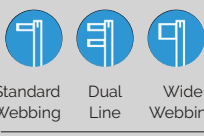

Standard Webbing 50mm width
Dual Line 50mm width (each line)
Wide Webbing 150mm width

Webbing Lengths

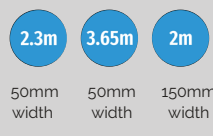

50mm width 50mm width 150mm width

Webbing Designs



Range of colours, designs and custom options

Tape End Options

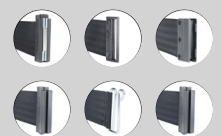

Six tape end options available

MILTON KEYNES
+44 1908 684 600

NEW YORK
+1 631 666 0336

DUBAI
+971 4 2997 228

PARIS
+33 1 43 09 85 00

FRANKFURT
+49 69 3003 89 010

WROCLAW
+48 71 359 3800